



Table of contents

+	+	+	Table of Contents	1
+	+	+	Usage Notice	3
			Safety Information	3
			Precautions	4
			Eye Safety Warnings	6
+	+	+	Introduction	7
			Package Overview	7
			Product Overview	8
			Main Unit	8
			Connection Ports	9
			Remote Control	10
+	+	+	Installation	11
			Connecting the Projector	11
			Connect to Notebook	11
			Connect to Video Sources	12
			Powering On/Off the Projector	13
			Powering On the Projector	13
			Powering Off the Projector	14
			Warning Indicator	14
			Adjusting the Projected Image	15
			Adjusting the Projector's Height	15
			Adjusting Projection Image Size	16
+	+	+	User Controls	17
			Remote Control	17
			On-screen Display Menus	19
			How to operate	19
			Menu Tree	20
			Image	21
			Image Advanced	23
			Display	24
			System	26
			System Lamp Settings	28
			System Startup Image	29
			System Network	30
			Setup	34
+	+	+	Appendices	38
			Troubleshooting	38
			Image	38
			Other	39

Table of contents

- Projector LED Status Indicator..... 40
- Remote Control..... 41
- Replacing the Lamp..... 42
- Compatibility Modes 45
- RS232 Commands and Protocol Function List..... 46
 - RS232 Pin Assignments (projector side) 46
 - RS232 Protocol Function List 47
- Ceiling Mount Installation 53
- Optoma Global Offices 54
- Regulation & Safety Notices..... 56

Safety Information

	The lightning flash with arrow head within an equilateral triangle is intended to alert the user to the presence of uninsulated "dangerous voltage" within the product's enclosure that may be of sufficient magnitude to constitute a risk of electric shock to persons.
	The exclamation point within an equilateral triangle is intended to alert the user to the presence of important operating and maintenance (servicing) instructions in the literature accompanying the appliance.

WARNING: TO REDUCE THE RISK OF FIRE OR ELECTRIC SHOCK, DO NOT EXPOSE THIS APPLIANCE TO RAIN OR MOISTURE. DANGEROUS HIGH VOLTAGES ARE PRESENT INSIDE THE ENCLOSURE. DO NOT OPEN THE CABINET. REFER SERVICING TO QUALIFIED PERSONNEL ONLY.

Class B emissions limits

This Class B digital apparatus meets all requirements of the Canadian Interference-Causing Equipment Regulations.

Important Safety Instruction

1. Do not block any ventilation openings. To ensure reliable operation of the projector and to protect from over heating, it is recommended to install the projector in a location that does not block ventilation. As an example, do not place the projector on a crowded coffee table, sofa, bed, etc. Do not put the projector in an enclosure such as a book case or a cabinet that restricts air flow.
2. Do not use the projector near water or moisture. To reduce the risk of fire and/or electric shock, do not expose the projector to rain or moisture.
3. Do not install near heat sources such as radiators, heaters, stoves or any other apparatus such as amplifiers that emits heat.
4. Clean only with dry cloth.
5. Only use attachments/accessories specified by the manufacturer.
6. Do not use the unit if it has been physically damaged or abused.
Physical damage/abuse would be (but not limited to):
 - Unit has been dropped.
 - Power supply cord or plug has been damaged.
 - Liquid has been spilled on to the projector.
 - Projector has been exposed to rain or moisture.
 - Something has fallen in the projector or something is loose inside.Do not attempt to service the unit yourself. Opening or removing covers may expose you to dangerous voltages or other hazards. Please call Optoma before you send the unit for repair.
7. Do not let objects or liquids enter the projector. They may touch dangerous voltage points and short out parts that could result in fire or electric shock.
8. See projector enclosure for safety related markings.
9. The unit should only be repaired by appropriate service personnel.

Precautions



Please follow all warnings, precautions and maintenance as recommended in this user's guide.

- Warning- Do not look into the projector's lens when the lamp is on. The bright light may hurt your eyes.
- Warning- To reduce the risk of fire or electric shock, do not expose this projector to rain or moisture.
- Warning- Please do not open or disassemble the projector as this may cause electric shock.
- Warning- When replacing the lamp, please allow the unit to cool down. Follow instructions as described on page 42.
- Warning- This projector will detect the life of the lamp itself. Please be sure to change the lamp when it shows warning messages.
- Warning- Reset the "Lamp Reset" function from the on-screen display "System|Lamp Setting" menu after replacing the lamp module (refer to page 28).
- Warning- When switching the projector off, please ensure the cooling cycle has been completed before disconnecting power. Allow 90 seconds for the projector to cool down.
- Warning- Do not use lens cap when projector is in operation.
- Warning- When the lamp is approaching to the end of its life time, the message "Replacement suggested" will show on the screen. Please contact your local reseller or service center to change the lamp as soon as possible.

Note

When the lamp reaches the end of its life, the projector will not turn back on until the lamp module has been replaced. To replace the lamp, follow the procedures listed under "Replacing the Lamp" section on page 42.

Usage Notice



Do:

- ■ Turn off and unplug the power plug from the AC outlet before cleaning the product.
- ■ Use a soft dry cloth with mild detergent to clean the display housing.
- ■ Disconnect the power plug from AC outlet if the product is not being used for a long period of time.



Do not:

- ■ Block the slots and openings on the unit provided for ventilation.
- ■ Use abrasive cleaners, waxes or solvents to clean the unit.
- ■ Use under the following conditions:
 - In extremely hot, cold or humid environments.
 - ▶ Ensure that the ambient room temperature is within 5 - 35°C
 - ▶ Relative Humidity is 5 - 35°C, 80% (Max.), non-condensing
 - In areas susceptible to excessive dust and dirt.
 - Near any appliance generating a strong magnetic field.
 - In direct sunlight.

Eye Safety Warnings



- ■ Avoid staring/facing directly into the projector beam at all times. Keep your back to the beam as much as possible.
- ■ When projector is used in a classroom, adequately supervise students when they are asked to point out something on the screen.
- ■ In order to minimize the lamp power, use room blinds to reduce ambient light levels.

Introduction

Package Overview

Unpack and inspect the box contents to ensure all parts listed below are in the box. If something is missing, please contact Optoma customer service.

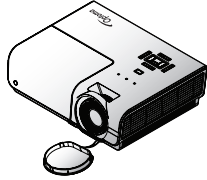

Projector with lens cap

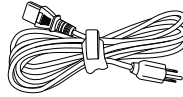

Power Cord 1.8m

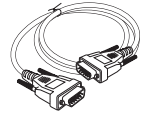

15 pin D-sub VGA Cable

Note

Due to different applications in each Country, some regions may have different accessories.



Remote Control



2 x AAA Batteries

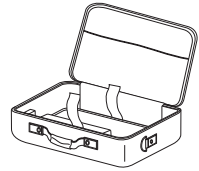

Carrying Case

Documentation :

- User's Manual
- Warranty Card
- Quick Start Guide
- WEEE Card

Introduction

Product Overview

Main Unit

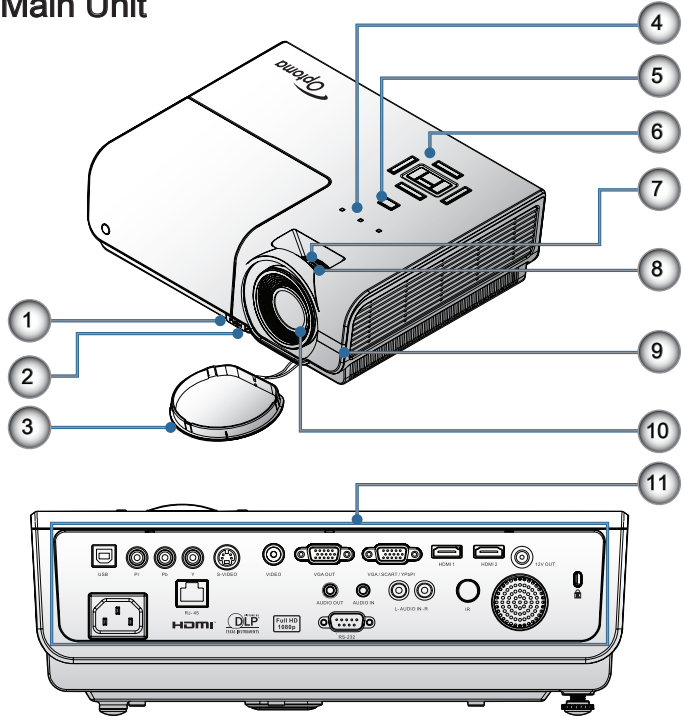

1. Tilt-Adjustment Button
2. Tilt-Adjustment Feet
3. Lens Cap
4. LED Indicators
5. Power Button
6. Function Keys
7. Zoom
8. Focus
9. IR Receiver
10. Lens
11. Connection Ports

Introduction

Connection Ports

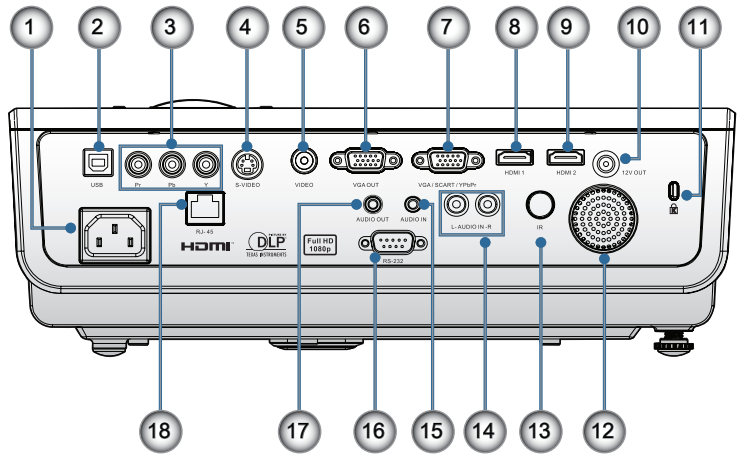

1. Power Socket
2. USB Connector (Connect to PC for Remote Mouse function)
3. Component Video
4. S-Video
5. Composite Video
6. VGA Output
7. VGA Input
8. HDMI 1
9. HDMI 2
10. 12V OUT
11. Kensington Microsaver™ Lock Port
12. Speaker
13. IR Receiver
14. AUDIO IN (L and R)
15. AUDIO IN
16. RS232
17. AUDIO OUT
18. LAN

Introduction

Remote Control

1. Laser
2. Status LED
3. Power
4. Up
5. Left
6. Enter
7. L
8. Source/Left Key
9. Enter
10. Keystone +/-
11. DVI-D/YPbPr/1
12. HDMI/4
13. S-Video/7
14. Menu/2
15. IR transmitter
16. Laser
17. Right
18. Down
19. R
20. ▲ / Page Up
21. Re-Sync/Right Key
22. Volume +/-
23. ▼ / Page Down
24. ZOOM/3
25. AV mute/6
26. Video/9
27. Freeze/5
28. VGA/8

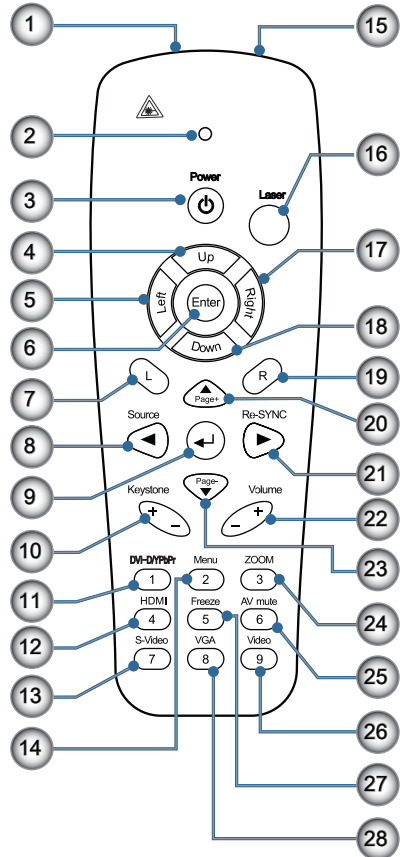

DVI-D function is model dependent.

Connecting the Projector Connect to Notebook

Note

Due to the difference in applications for each country, some regions may have different accessories.

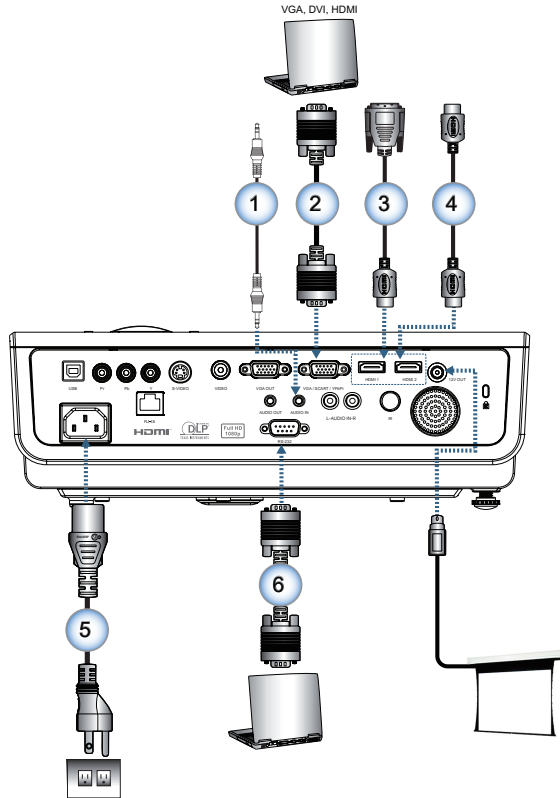

- 1.....Audio Cable (Optional Accessory)
- 2.....VGA Input Cable
- 3.....DVI/HDMI Cable (Optional Accessory)
- 4.....HDMI Cable (Optional Accessory)
- 5.....Power Cord
- 6.....RS232 Cable (Optional Accessory)

Installation

Connecting the Projector Connect to Video Sources

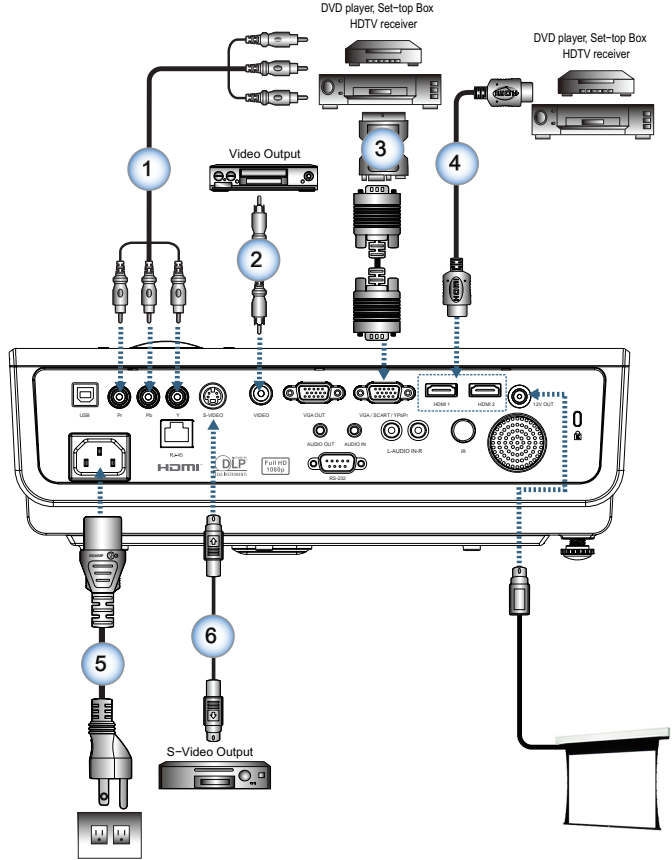

Note

Due to the difference in applications for each country, some regions may have different accessories.

Note

12V OUT is a programmable trigger.

- 1..... RCA Component Cable for YPbPr (Optional Accessory)
- 2..... Composite Video Cable (Optional Accessory)
- 3..... SCART RGB/S-Video Adapter (Optional Accessory)
- 4..... HDMI Cable (Optional Accessory)
- 5..... Power Cord
- 6..... S-Video Cable (Optional Accessory)

Powering On/Off the Projector

Powering On the Projector

1. Remove the lens cover.
2. Connect the power cord to the projector.
3. Turn On the connected devices.
4. Ensure the Power LED is flashing and then press the power button to turn On the projector.



Turn on the projector first and then select the signal sources.

The projector's startup logo screen displays and connected devices are detected. If the connected device is a laptop, press the appropriate keys on the computer keyboard to switch the display output to the projector. (Check the user manual of the laptop to determine the appropriate Fn key combination to change display output.)

See Security Settings on page 37 if security lock is enabled.



Due to the difference in applications for each country, some regions may have different accessories.

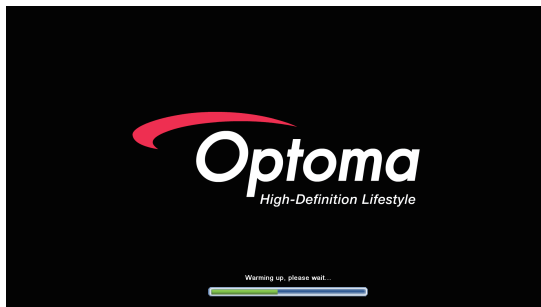

5. If more than one input device is connected, press the "Source" button sequentially to switch between devices. For direct source selection, see page 18.



12V OUT is a programmable trigger.



Installation

Powering Off the Projector

1. Press the "⏻" button on the remote control or "⏻" button on the panel of the projector to turn off the projector. First push of button will display the following message on the screen.

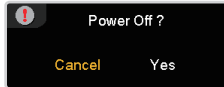

Press the button again to confirm the shut down. If the button is not pressed, the message will disappear in 15 seconds.

2. The Power LED flashes green and the fans will speed up during shut down cooling cycle. The projector reaches stand-by mode as soon as the Power LED turns red.
If you wish to turn the projector back on, you must wait until the projector has completed the cooling cycle and has entered standby mode. Once in standby mode, simply press "⏻" button on the rear of the projector or "⏻" on the remote control to restart the projector.
3. Disconnect the power cord from the electrical outlet and the projector only when the projector is in stand-by mode.

Warning Indicator

- When the Lamp LED indicator lights red, the projector will automatically shut itself down. Please contact your local reseller or service center. See pages 40.
- When the Temp LED is on a steady (not flashing) red, the projector will automatically shut itself down. Under normal conditions, the projector can be switched on again after it has cooled down. If the problem persists, you should contact your local dealer or our service center. See pages 40.



Contact the nearest service center if the projector displays these symptoms. See page 54 for more information.

Adjusting the Projected Image

Adjusting the Projector's Height

The projector is equipped with elevator feet for adjusting the image height.

Note

- The projector table or stand should be level and sturdy.
- Position the projector so that it is perpendicular to the screen.
- For personal safety, please secure the cables properly.

To raise the image:

Lift the projector ① and press the height-adjuster button ②. The height adjuster drops down ③.

To lower the image:

Press the height-adjuster button and gently push down the projector.

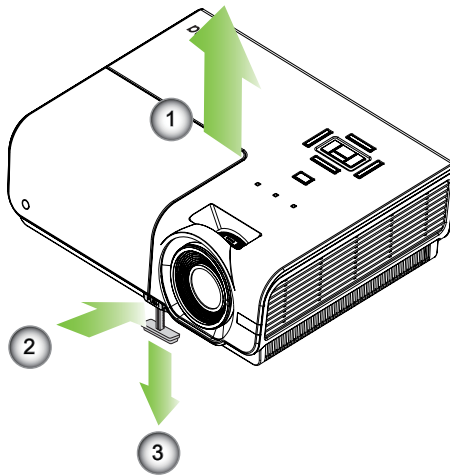

Installation

Adjusting Projection Image Size

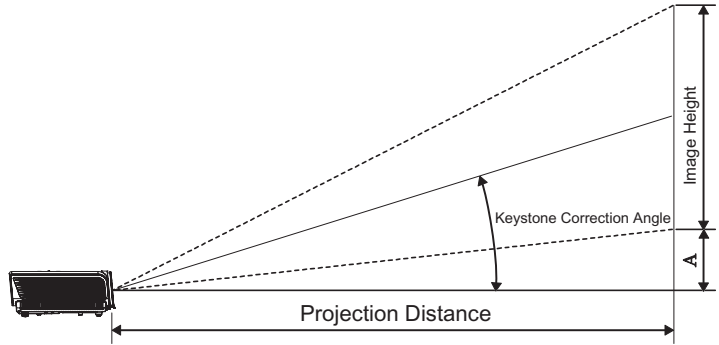

Standard projection lens: Wide - 1.59 Tele - 1.908

Diagonal length (inch) size of 16:9 Screen	Screen Size W X H (16:9)				Projection distance (D)				Offset (A)	
	(m)		(feet)		(m)		(feet)			
	Width	Height	Width	Height	wide	tele	wide	tele	(m)	(feet)
30.00	0.66	0.37	2.18	1.23	-	1.27	-	4.16	0.06	0.18
40.00	0.89	0.50	2.91	1.63	1.41	1.69	4.62	5.54	0.07	0.25
60.00	1.33	0.75	4.36	2.45	2.11	2.53	6.93	8.31	0.11	0.37
80.00	1.77	1.00	5.81	3.27	2.82	3.38	9.24	11.09	0.15	0.49
100.00	2.21	1.25	7.26	4.09	3.52	4.22	11.55	13.86	0.19	0.61
120.00	2.66	1.49	8.72	4.90	4.22	5.07	13.86	16.63	0.22	0.74
140.00	3.10	1.74	10.17	5.72	4.93	5.91	16.17	19.40	0.26	0.86
160.00	3.54	1.99	11.62	6.54	5.63	6.76	18.48	22.17	0.30	0.98
190.00	4.21	2.37	13.80	7.76	6.69	8.03	21.94	26.33	0.35	1.16
230.00	5.09	2.86	16.71	9.40	8.10	9.72	26.56	31.87	0.43	1.41
280.00	6.20	3.49	20.34	11.44	9.86	11.83	32.34	38.80	0.52	1.72
300.00	6.64	3.74	21.79	12.26	10.56	-	34.65	-	0.56	1.84









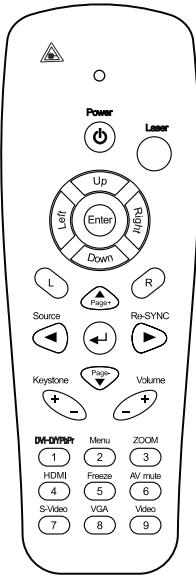







300" (overdrive)
for Asia.

User Controls

Remote Control









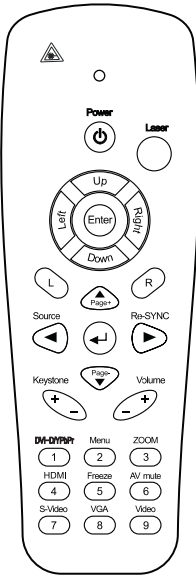





Using the Remote Control

	Power On/Off	Refer to the "Power On the Projector" section on page 13.
	Laser	Refer to the "Power Off the Projector" section on page 14.
	Laser	Press to operate the on-screen pointer.
	Up	Up arrow when connected through USB to a PC.
	Left	Left arrow when connected through USB to a PC.
	Down	Down arrow when connected through USB to a PC.
	Right	Right arrow when connected through USB to a PC.
	Enter	Enter key when connected through USB to a PC.
	L	L key for emulation of USB mouse left click via USB.
		Up selection when OSD on.
	Page+	Page Up key for emulation of USB keyboard via USB when OSD off.
	R	R key for emulation of USB mouse right click via USB
	Source	Press "Source" to choose RGB, Component, S-Video, Composite Video, and HDMI source.
	Left Directional Select Key	Use directional select keys to select items or make adjustments to your selection.
	Enter	Confirm your item selection.

User Controls



Using the Remote Control

	<p>Re-Sync</p> <p>Right Directional Select Key</p>	<p>Automatically synchronize the projector to the input source.</p> <p>Use directional select keys to select items or make adjustments to your selection.</p>
	<p>Page-</p>	<p>Down selection when OSD on.</p> <p>Page Down key for emulation of USB keyboard via USB when OSD off.</p>
	<p>Keystone +/-</p>	<p>Press "Keystone +/-" to correct image-trapezoid (wider top/bottom) effect.</p>
	<p>Volume +/-</p>	<p>Press "Volume +/-" to adjust volume.</p>
	<p>DVI-D/YPbPr/1</p>	<p>Press "DVI-D/YPbPr" to choose Component Video source.</p>
	<p>Menu/2</p>	<p>Display or exit the on-screen display menus for projector.</p>
	<p>ZOOM/3</p>	<p>Press "ZOOM" to zoom out images.</p>
	<p>HDMI/4</p>	<p>Press "HDMI" to choose source from HDMI connectors.</p>
	<p>Freeze/5</p>	<p>Press "Freeze" to freeze or unfreeze the on-screen picture.</p>
	<p>AV Mute/6</p>	<p>Press "AV Mute" to mute the built-in speaker.</p>
	<p>S-Video/7</p>	<p>Press "S-Video" to choose S-video source.</p>
	<p>VGA/8</p>	<p>Press "VGA" to choose source from VGA connector.</p>
	<p>Video/9</p>	<p>Press "Video" to choose Composite Video source.</p>

On-screen Display Menus

The Projector has multilingual On-screen Display menus that allow you to make image adjustments and change a variety of settings. The projector will automatically detect the source.

How to operate

1. To open the OSD menu, press "Menu" on the Remote Control or Control Panel.
2. When OSD is displayed, use ▲ ▼ keys to select any item in the main menu. While making a selection on a particular page, press ◀ ▶ or "↶" key on the Remote Control or "Enter" on the Control Panel to enter sub menu.
3. Use ▲ ▼ keys to select the desired item and adjust the settings by ◀ ▶ key.
4. Select the next item to be adjusted in the sub menu and adjust as described above.
5. Press "↶" key on the Remote Control or "Enter" on the Control Panel or "Menu" to confirm, and the screen will return to the main menu.
6. To exit, press "Menu" again. The OSD menu will close and the projector will automatically save the new settings.

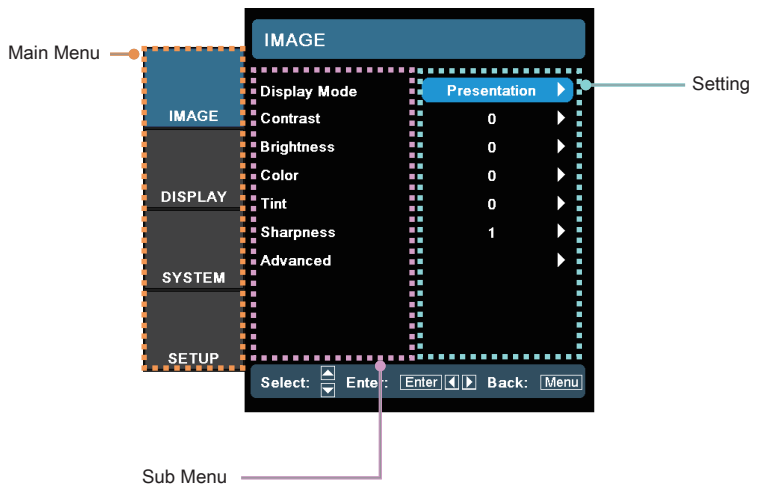

User Controls

Menu Tree

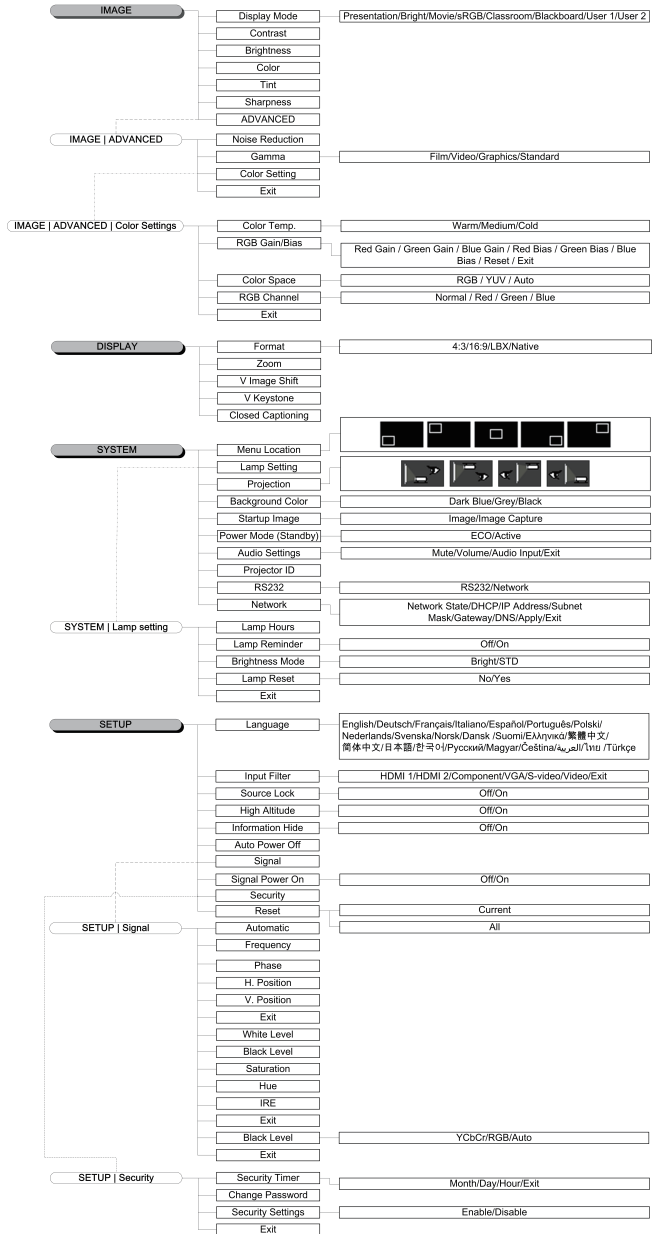

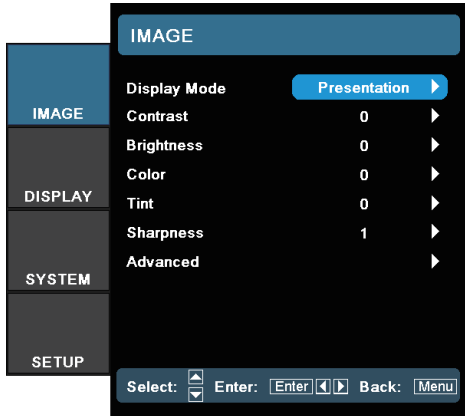

Image

Display Mode

There are many factory presets optimized for various types of images.

- ▶ Presentation: Good color and brightness from PC input.
- ▶ Brightness: Optimized for maximum brightness.
- ▶ Movie: For home theater.
- ▶ sRGB: Standardised accurate color.
- ▶ Classroom: Recommended settings for classroom.
- ▶ Blackboard: Tuned for blackboard usage.
- ▶ User 1: User's own settings.
- ▶ User 2: User's own settings.

The initial default settings of this mode is from Presentation mode. Any further adjustments by the user in User1/2 will be saved in this mode for future use.

Contrast

The contrast controls the degree of difference between the lightest and darkest parts of the picture. Adjusting the contrast changes the amount of black and white in the image.

- ▶ Press the ◀ to decrease the contrast.
- ▶ Press the ▶ to increase the contrast.

User Controls

Brightness

Adjust the brightness of the image.

- ▶ Press the ◀ to darken image.
- ▶ Press the ▶ to lighten the image.

Color

Adjust a video image from black and white to fully saturated color.

- ▶ Press the ◀ to decrease the color saturation in the image.
- ▶ Press the ▶ to increase the color saturation in the image.

Tint

Adjust the color balance of red and green.

- ▶ Press the ◀ to increase the amount of green in the image.
- ▶ Press the ▶ to increase the amount of red in the image.

Sharpness

Adjust the sharpness of the image.

- ▶ Press the ◀ to decrease the sharpness.
- ▶ Press the ▶ to increase the sharpness.

Advanced

Use this option to enter the Advanced menu see page 23.

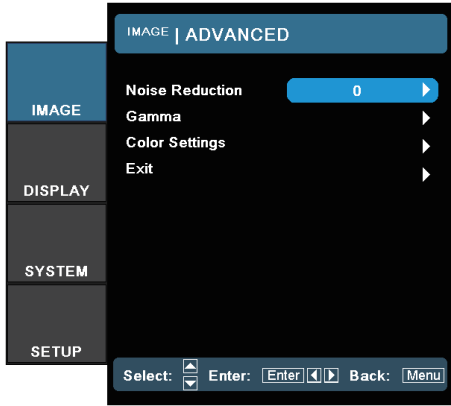

Image | Advanced

Noise Reduction

The motion Adaptive Noise Reduction reduces the amount of visible noise in interlaced signals. The range is from "0" to "10". (0=Off)

Gamma

This allows you to set up gamma curve type. After the initial setup and fine tuning is completed, utilize the Gamma Adjustment steps to optimize your image output.

- ▶ Film: for date projector.
- ▶ Video: for video or TV source.
- ▶ Graphics: for image source.
- ▶ Standard: for standardized setting.

Color Settings

- ▶ Color Temperature: Adjust the color temperature. Cold temperature, the screen looks colder; with Warm temperature, the screen looks warmer.
- ▶ RGB Gain/Bias: Press ▶ into the next menu as below and then ▲ or ▼ to select item. Use ◀ or ▶ to select Red, Green, or Blue for brightness (Gain) and contrast (Bias).
- ▶ Color Space: Select an appropriate color matrix type from RGB or YCbCr.
- ▶ RGB Channel: Select this menu to adjust the RGB Bias and Gain levels for each primary (RGB) color.

User Controls

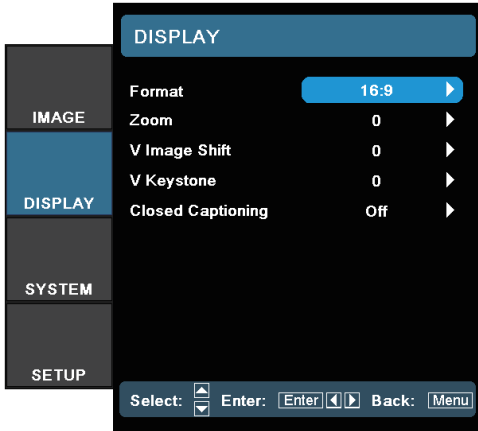

Display

Format

Use this function to choose your desired aspect ratio.

- ▶ 4:3: This format is for 4x3 input sources.
- ▶ 16:9: This format is for 16x9 input sources, like HDTV and DVD enhanced for Widescreen TV.
- ▶ Letter Box: This format is for non-16x9, letterbox source and for users who use external anamorphic lens to display 2.35:1 aspect ratio using full resolution.

Detail informations about Letter Box mode :

1. Some Letter-Box DVDs are not enhanced for 16x9 TVs. In this situation, the image will not look right when displayed in 16:9 mode.

In this situation, please try to using the 4:3 mode to view the DVD.

If the content is not 4:3, there will be black bars around the image in 16:9 display. For this type of content, you can use LBX mode to fill the image on the 16:9 display.

2. If you use an external anamorphic lens, this LBX mode also allows you to watch a 2.35:1 content (include Anamorphic DVD and HDTV film source) that support anamorphic wide is enhanced for 16x9 Display in a wide 2.35:1 image.

In this case, there are no black bars. Lamp power and vertical resolution are fully utilized.

User Controls

- ▶ Native: This format displays the original image without any scaling.

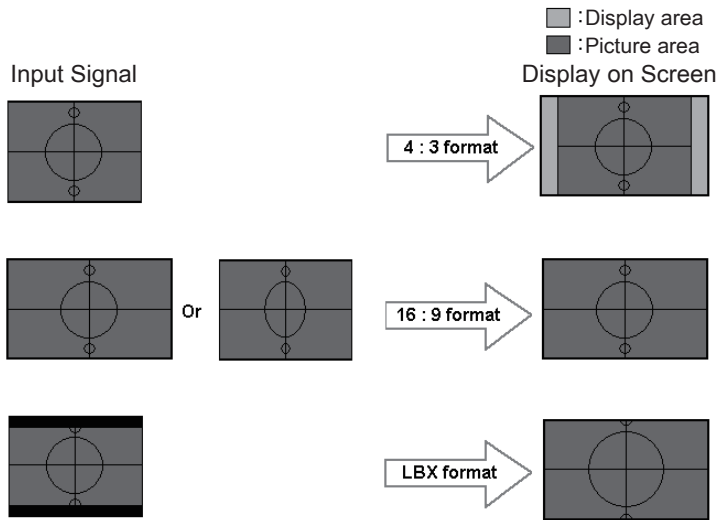

Zoom

- ▶ Press ◀ to reduce the size of the image.
- ▶ Press ▶ to magnify an image on the projected screen.

V Image Shift

Shift the projected image position vertically.

V Keystone

Press the ◀ or ▶ to adjust image distortion vertically and make a squarer image.

Closed Captioning

Select the screen to display closed captioning.

- ▶ Off-the supplied default setting.
- ▶ CC1 | CC2-closed captioning type select.

User Controls

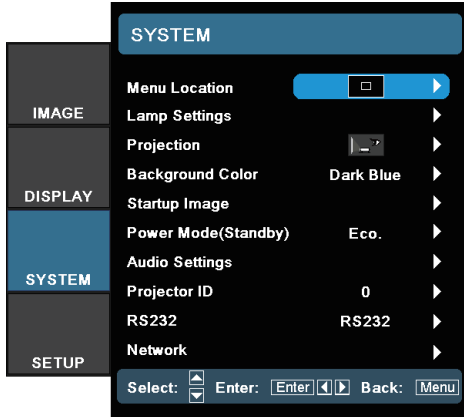

System

Menu Location

Choose the menu location on the display screen.

Lamp Settings

Choose this menu to adjust your desired lamp setting.

Projection

- ▶  Front-Projection

This is the default selection. The image is projected straight on the screen.

- ▶  Rear-Desktop

When selected, the image will appear reversed.

- ▶  Front-Ceiling

When selected, the image will turn upside down.

- ▶  Rear-Ceiling

When selected, the image will appear reversed in upside down position.

Background Color

Use this feature to display a "Dark Blue", "Gray", or "Black" screen when no signal is available.

Startup Image

Select the screen to display during startup.

Note

Rear-Desktop and Rear-Ceiling are to be used with a translucent screen.

User Controls

Power Mode (Standby)

Set the projector in ECO Mode or Active Mode.

Audio Settings

Enter the Audio Settings menu. Set audio level properties.

Projector ID

Select a two digit projector ID from 0 through 99.

RS232

Allows RS232 control of an individual projector.

Network

Allows LAN via web browser (Internet Explore) to control of projector. See pages 30 for more information.

User Controls

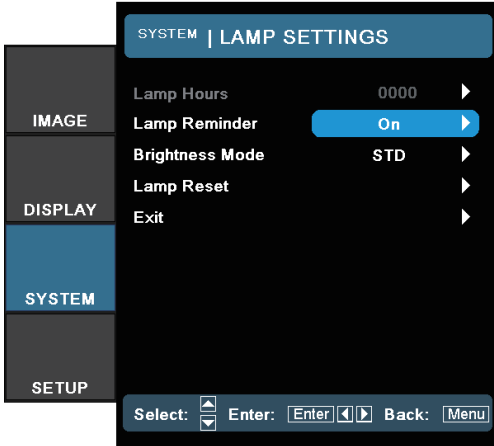

System / Lamp Settings

Lamp Hour

Display the cumulative lamp operating time.

Lamp Reminder

Choose this function to turn on the lamp reminder. Lamp reminder will pop up 30 hours before reaching end of its life.

Brightness Mode

Choose "Bright" to increase the lamp brightness. Choose "STD" to return to normal mode.

Lamp Reset

Reset the lamp life hour after replacing the lamp.

System / Startup Image

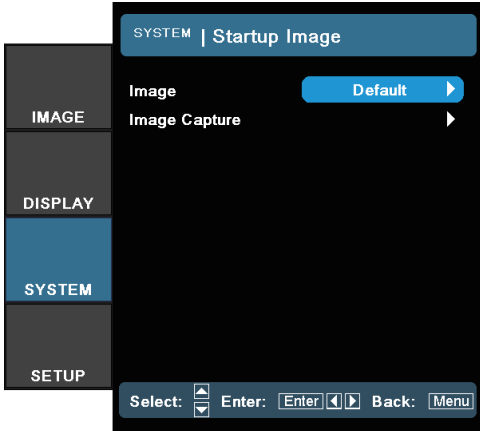

Image

Select the screen to display during startup.

- ▶ Default - the supplied default startup screen.
- ▶ User - customized screen capture using the Image Capture function.

Note

Startup Capture support in:

- HDMI 720p/1080p
- VGA 1920X1080@60Hz
- YPbPr 720p/1080p

Image Capture

Capture a displayed screen to use as the startup screen.

1. Display the desired screen on the projector.
2. Select Image Capture from the Advanced menu.
3. Select OK. Screen capture in progress will display. When finished, Screen capture Succeeded will display. The captured screen is saved as User in the Image menu.

User Controls

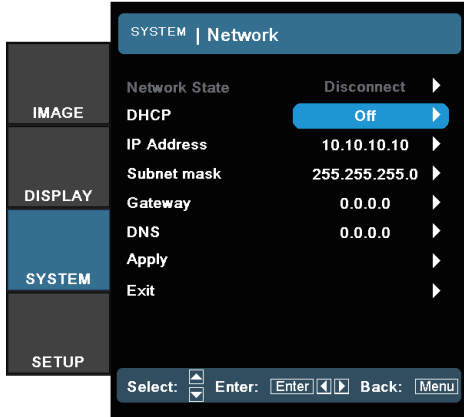

System / Network

For simplicity and ease of operation, the Optoma projector provides diverse networking and remote management features. The Network function of the projector through a network, such as remotely manage: Power On/Off, Brightness and Contrast settings. Also, projector status information, such as: Video-Source, Sound-Mute, etc.

Note

- Use straight-thru cable when connecting to a hub, switch or a router.
- Use crossover cable for direct PC to projector connection.

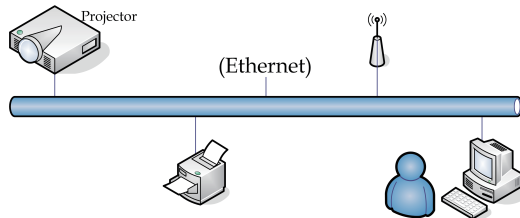

1. Connect an RJ45 cable to RJ45 ports on the projector and the PC (Laptop).

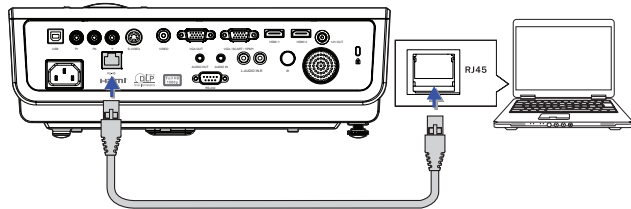

User Controls

2. On the PC (Laptop), select Start -> Control Panel -> Network Connections.

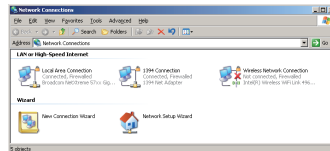
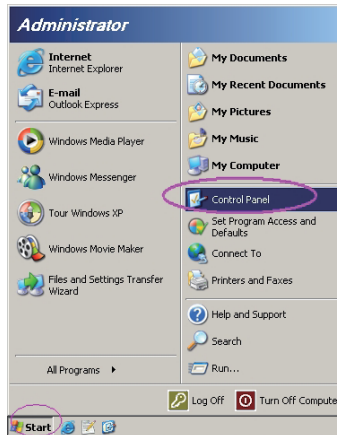

3. Right click on your Local Area Connection and select Properties.

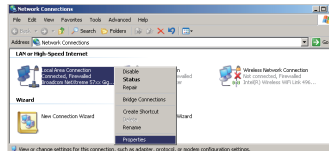

4. In the Properties window, select the General tab, and select Internet Protocol (TCP/IP).
5. Click Properties.

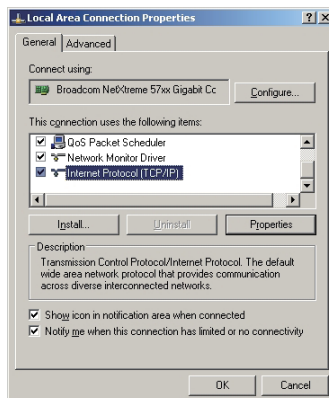

User Controls

6. Fill in the IP address and Subnet mask, then press OK.

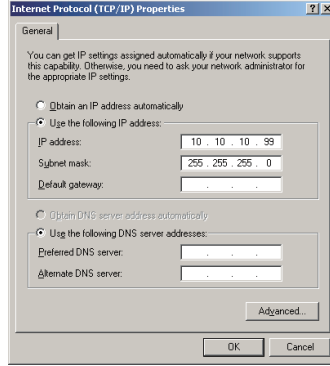

7. Press the Menu button on the projector.
8. Select OSD-> SETUP-> Network-> Enabled.
9. Input the following:
 - ▶ IP Address: 10.10.10.10
 - ▶ Subnet Mask: 255.255.255.0
 - ▶ Gateway: 0.0.0.0
 - ▶ DNS: 0.0.0.0
10. Press Apply (Enter) to confirm settings.
11. Open a web browser.

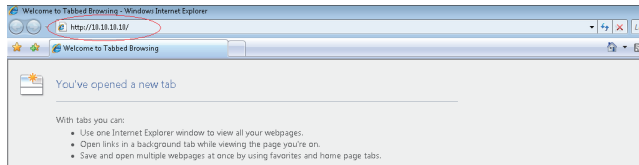

12. In the Address bar, input the IP address: 10.10.10.10.
13. Press Apply.

The projector is setup for remote management. The Network function displays as follows.

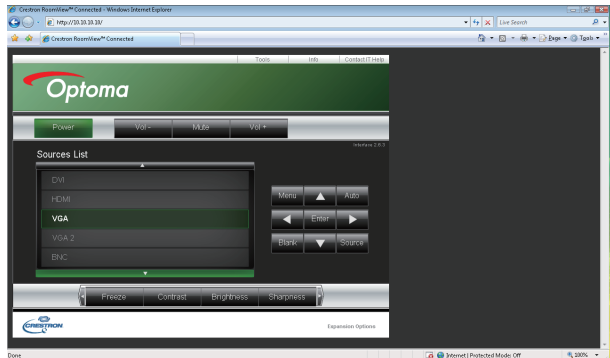

User Controls

14. Based on network web-page for the input-string in **[tools]** tab, the limitation for Input-Length is in the below list ("space" and the other punctuation key included):

Category	Item	Input-Length (characters)
Crestron Control	IP Address	15
	IP ID	2
	Port	5
Projector	Projector Name	10
	Location	9
	Assigned To	9
Network Configuration	DHCP (Enabled)	(N/A)
	IP Address	15
	Subnet Mask	15
	Default Gateway	15
User Password	DNS Server	15
	Enabled	(N/A)
	New Password	15
Admin Password	Confirm	15
	Enabled	(N/A)
	New Password	15
	Confirm	15



For more information, please visit <http://www.crestron.com>

Tools | Info | Contact IT Help

<p>Crestron Control</p> <p>IP Address: <input type="text" value="192.168.0.20"/></p> <p>IP ID: <input type="text" value="03"/></p> <p>Port: <input type="text" value="41794"/></p> <p style="text-align: right;"><input type="button" value="Send"/></p>	<p>Projector</p> <p>Projector Name: <input type="text" value="A01"/></p> <p>Location: <input type="text" value="Room"/></p> <p>Assigned To: <input type="text" value="Sir."/></p> <p style="text-align: right;"><input type="button" value="Send"/></p> <p>DHCP <input type="checkbox"/> Enabled</p> <p>IP Address: <input type="text" value="10.10.10.10"/></p> <p>Subnet Mask: <input type="text" value="255.255.255.0"/></p> <p>Default Gateway: <input type="text" value="0.0.0.0"/></p> <p>DNS Server: <input type="text" value="0.0.0.0"/></p> <p style="text-align: right;"><input type="button" value="Send"/></p>	<p>User Password</p> <p><input type="checkbox"/> Enabled</p> <p>New Password: <input type="password"/></p> <p>Confirm: <input type="password"/></p> <p style="text-align: right;"><input type="button" value="Send"/></p> <p>Admin Password</p> <p><input type="checkbox"/> Enabled</p> <p>New Password: <input type="password"/></p> <p>Confirm: <input type="password"/></p> <p style="text-align: right;"><input type="button" value="Send"/></p>
---	---	--

User Controls

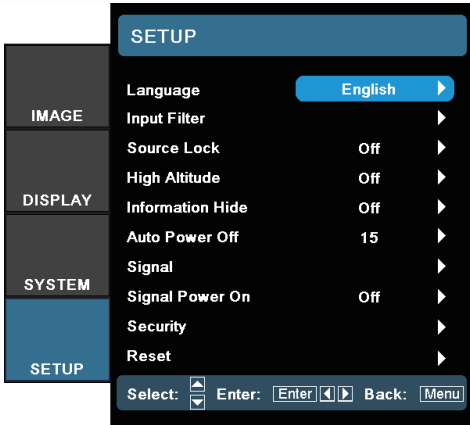

Setup

Language

Choose the multilingual OSD menu. Press ◀ or ▶ into the sub menu and then use the ▲ or ▼ key to select your preferred language. Press "Select (Enter)" to finalize the selection.

Input Filter

Enable the input filter. Press ◀ or ▶ into the next menu as below and then use ▲ or ▼ to select. Press "Select (Enter)" to finalize the selection. The projector will not search inputs that are de-selected.

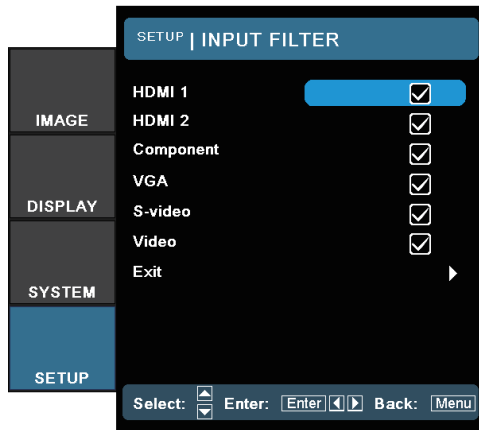

Source Lock

When this function is turned off, the projector will search for other signals if the current input signal is lost. When this function is turned on, it will search for a specified connection port.

High Altitude

Choose "On" to turn on High Altitude mode. Operates the fans at full speed continuously to allow for proper high altitude cooling of the projector.

Information Hide

Suppress informational messages on the projected screen.

- ▶ On: No status messages appear on screen during operation.
- ▶ Off: Status messages appear as normal on screen during operation.

Auto Power Off

Set the time interval (in minutes) to power off the system if there is no input signal detected.

Signal

VGA Source

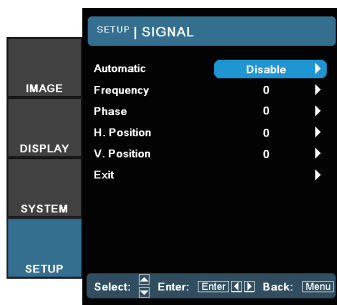

Video Source

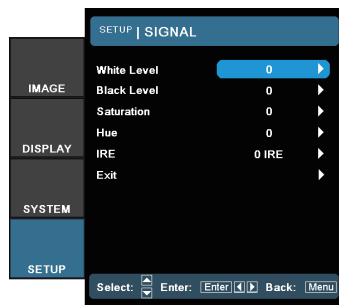

HDMI Source

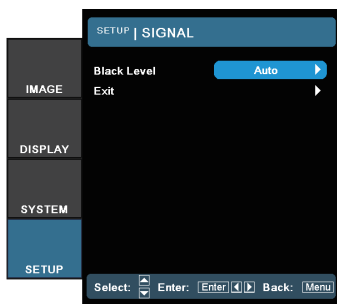

User Controls



"IRE" is only supported on NTSC signal.

- ▶ Automatic: Enable or disable Automatic to automatically select the appropriate settings.
 - Enabled - the projector will automatically select the appropriate settings.
 - Disabled - the projector won't automatically select the appropriate settings.
- ▶ Frequency: Change the display data frequency to match the frequency of your computer's graphic card. When you experience a vertical flickering bar, use this function to make an adjustment.
- ▶ Phase: Synchronize the signal timing of the display with the graphics card. If you experience an unstable or flickering image, use this function to correct it.
- ▶ H Position: Adjust the horizontal position.
- ▶ V Position: Adjust the vertical position.
- ▶ White Level: Allow user to adjust White Level when inputting SVideo or Video/CVBS signals.
- ▶ Black Level: Allow user to adjust Black Level when inputting SVideo or Video/CVBS signals.
- ▶ Saturation: Adjust a video image from black and white to fully saturated color. Press the ◀ to decrease the amount of color in the image. Press the ▶ to increase the amount of color in the image.
- ▶ Hue: Adjust the color balance of red and green. Press the ◀ to increase the amount of green in the image. Press the ▶ to increase the amount of red in the image.
- ▶ IRE: Adjust measurement of composite video signals.
- ▶ Black Level (for HDMI): Allows user to adjust the Black Level for HDMI signals.

Signal Power On

- ▶ Off: Projector can only be turned on by pressing the "Power" button.
- ▶ On: Projector turns on automatically when an active signal is detected.



No password is required to access Setup | Security unless the Security Timer or Security Settings are enabled.

Security

- ▶ **Security Timer:** Enter the Security Timer sub menu to change the settings.
Enter the Months, Days, and hours that the projector can be used without entering the password. Exiting to the Setup menu activates the Security Timer.
Once activated, the projector requires a password on the specified dates and times to allow power on and access to the security menu.
If the projector is in use and the Security Timer is active, the Password screen displays 60 seconds before the password is required.
- ▶ **Security Setting:** Enable or disable the security password.
 - Enabled - the current password is required to power on the projector and access the Security menu.
 - Disabled - Disabled-no password is required for any function.

When security is enabled, the Password screen displays at startup and before access to the Security menu is allowed:

Reset

Return the adjustments and settings to factory default values.

- ▶ **Current:** Return the current menu's settings to factory default.
- ▶ **All:** Return the settings for all menus to factory default values.

Troubleshooting

If you experience a problem with your projector, please refer to the following information. If a problem persists, please contact your local reseller or service center.

Image

? No image appears on-screen

- ▶ Ensure all the cables and power connections are correctly and securely connected as described in the "Installation" section.
- ▶ Ensure the pins of connectors are not crooked or broken.
- ▶ Check if the projection lamp has been securely installed. Please refer to the "Replacing the Lamp" section.
- ▶ Make sure you have removed the lens cap and the projector is switched on.

? Image is out of focus

- ▶ Make sure the Lens cap is removed.
- ▶ Adjust the Focus Ring on the projector lens.
- ▶ Make sure the projection screen is between the required distance from the projector. See pages 16.

? The image is stretched when displaying 16:9 DVD title

- ▶ When you play anamorphic DVD or 16:9 DVD, the projector will show the best image in 16: 9 format on projector side.
- ▶ If you play the LBX format DVD title, please change the format as LBX in projector OSD.
- ▶ If you play 4:3 format DVD title, please change the format as 4:3 in projector OSD.
- ▶ If the image is still stretched, you will also need to adjust the aspect ratio by referring to the following:
- ▶ Please setup the display format as 16:9 (wide) aspect ratio type on your DVD player.

? Image is too small or too large

- ▶ Adjust the zoom lever from the lens.
- ▶ Move the projector closer to or further from the screen.
- ▶ Press [Menu] on the projector panel, go to "Display->Format". Try the different settings.

? Image has slanted sides:

- ▶ If possible, reposition the projector so that it is centered on the screen and below the bottom of the screen and use PureShift to make adjustments to the image position.
- ▶ Use "Display->V Keystone" from the OSD to make an adjustment.

? Image is reversed

- ▶ Select "System->Projection" from the OSD and adjust the projection direction.

Other

? The projector stops responding to all controls

- ▶ If possible, turn off the projector, then unplug the power cord and wait at least 20 seconds before reconnecting power.

? Lamp burns out or makes a popping sound

- ▶ When the lamp reaches its end of life, it will burn out and may make a loud popping sound. If this happens, the projector will not turn on until the lamp module has been replaced. To replace the lamp, follow the procedures in the "Replacing the Lamp" section on page 48.

Appendices

Projector LED Status Indicator

Message	Power LED □ Power (Green)	Temp LED □ Temp (Red)	Lamp LED □ Lamp (Red)
Standby State (Input power cord)	Slow Flashing 2 sec off 2 sec on	○	○
Power on (Warming)	Flashing 0.5 sec off 0.5 sec on	○	○
Power on & Lamp lighting	☀	○	○
Power off (Cooling)	Flashing 1 sec off 1 sec on < 10 sec to off	○	○
Error (Lamp fail)	Flashing 0.5 sec off 0.5 sec on	○	☀
Error (Fan fail)	Flashing 0.5 sec off 0.5 sec on	Flashing 0.5 sec off 0.5 sec on	○
Error (Over Temp)	Flashing 0.5 sec off 0.5 sec on	☀	○



Steady light => ☀
No light => ○

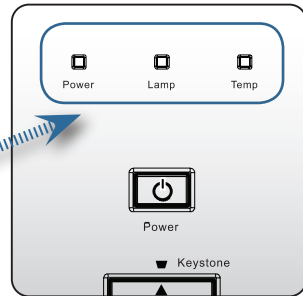
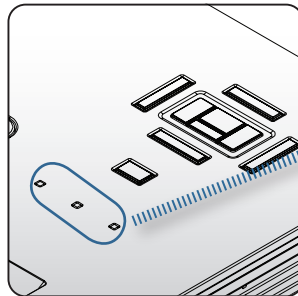

? LED states

? On Screen Messages

- ▶ Fan failed:

The projector will switch off automatically.

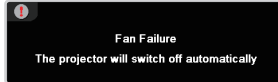

- ▶ Over temperature:

The projector will switch off automatically.

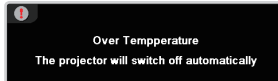

- ▶ Replacing the lamp:

Lamp is approaching the end of its rated life.

Replacement suggested.

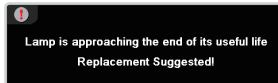

Warning:
Only use genuine
lamps.

Remote Control

? If the remote control does not work

- ▶ Check the operating angle of the remote control is within $\pm 15^\circ$ both horizontally and vertically of one of the IR receivers on the projector.
- ▶ Make sure there are no any obstructions between the remote control and the projector. Move to within 7 m (23 ft) of the projector.
- ▶ Make sure batteries are inserted correctly.
- ▶ Replace batteries if they are exhausted.

Replacing the Lamp

The projector automatically detects the lamp life. When the lamp life is nearing the end of use, you will receive a warning message.

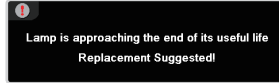

When you see this message, please contact your local reseller or service center to change the lamp as soon as possible. Make sure the projector has been cooled down for at least 30 minutes before changing the lamp.



Warning: Lamp compartment is hot! Allow it to cool down before changing lamp!



Warning: To reduce the risk of personal injury, do not drop the lamp module or touch the lamp bulb. The bulb may shatter and cause injury if it is dropped.

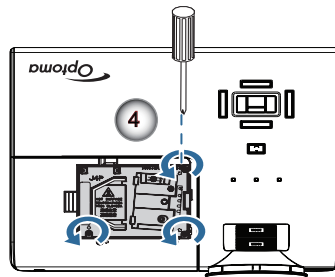
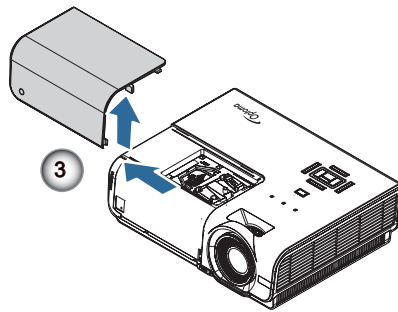
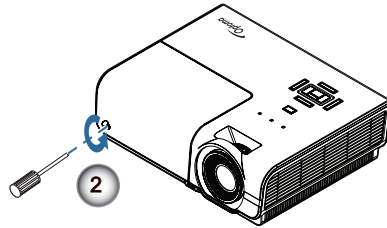
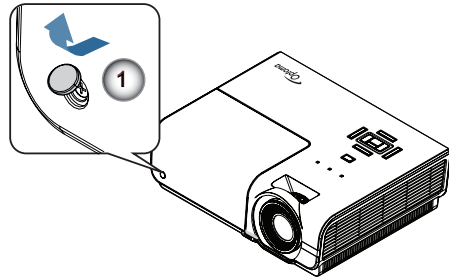

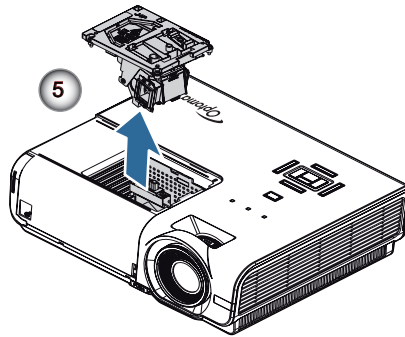

Lamp Replacing Procedure:

1. Switch off the power to the projector by pressing the Power button.
2. Allow the projector to cool down at least 30 minutes.
3. Disconnect the power cord.
4. Open the screw cover. ❶
5. Remove the single screw on the lamp compartment cover. ❷
6. Remove the lamp compartment cover. ❸
7. Remove the three screws from the lamp module.
Lift the module handle up. ❹
8. Pull firmly on the module handle to remove the lamp module. ❺

To replace the lamp module, reverse the previous steps. While installing, align the lamp module with the connector and ensure it is level to avoid damage.

9. Turn on the projector and do "Lamp Reset" after the lamp module is replaced.

Lamp Reset: (i) Press "Menu" -> (ii) Select "System" -> (iii) Select "Lamp Settings" -> (iv) Select "Lamp Reset" -> (v) Select "Yes".

Compatibility Modes

Signal	Resolution	H-SYNC (KHz)	V-SYNC (Hz)	COMPOSITE S_VIDEO	COMPONENT	RGB (Analog)	DVI (Digital)
NTSC	*	15.734	60.0	✓	*	*	*
PAL/SECAM	*	15.625	50.0	✓	*	*	*
VESA	720 x 400	37.9	85.0	*	*	✓	✓
	640 x 480	31.5	60.0	*	*	✓	✓
	640 x 480	37.9	72.8	*	*	✓	✓
	640 x 480	37.5	75.0	*	*	✓	✓
	640 x 480	43.3	85.0	*	*	✓	✓
	800 x 600	35.2	56.3	*	*	✓	✓
	800 x 600	37.9	60.3	*	*	✓	✓
	800 x 600	46.9	75.0	*	*	✓	✓
	800 x 600	48.1	72.2	*	*	✓	✓
	800 x 600	53.7	85.1	*	*	✓	✓
	1024 x 768	48.4	60.0	*	*	✓	✓
	1024 x 768	56.5	70.1	*	*	✓	✓
	1024 x 768	60.0	75.0	*	*	✓	✓
	1024 x 768	68.7	85.0	*	*	✓	✓
	1280 x 800	49.7	59.8	*	*	✓	✓
1280 x 800	62.8	74.9	*	*	✓	✓	
1280 x 800	71.6	84.8	*	*	✓	✓	
1280 x 1024	64.0	60.0	-	*	○	✓	✓
	1280 x 1024	80.0	75.0	*	*	✓	✓
	1280 x 1024	91.1	85.0	*	*	✓	✓
	1400 x 1050	65.3	60.0	*	*	✓	✓
	1440 x 900	55.9	60.0	*	*	✓	✓
	1600 x 1200	75.0	60.0	*	*	✓	✓
	1920 x 1080	67.2	60.0	*	*	✓	✓
Apple Macintosh	640 x 480	35.0	66.7	*	*	✓	✓
	832 x 624	49.7	74.5	*	*	✓	✓
	1024 x 768	60.2	74.9	*	*	✓	✓
	1152 x 870	68.7	75.1	*	*	✓	✓
SDTV	480i	15.734	60.0	*	✓	*	*
	576i	15.625	50.0	*	✓	*	*
EDTV	576p	31.3	50.0	*	✓	*	*
	480p	31.5	60.0	*	✓	*	*
HDTV	720p	37.5	50.0	*	✓	*	*
	720p	45.0	60.0	*	✓	*	*
	1080i	33.8	60.0	*	✓	*	*
	1080i	28.1	50.0	*	✓	*	*
	1080p	67.5	60.0	*	✓	*	*
	1080p	56.3	50.0	*	✓	*	*

RS232 Commands and Protocol Function List

RS232 Pin Assignments (projector side)

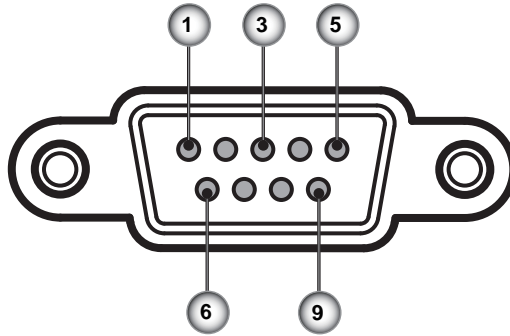

Pin no.	Name	I/O (From Projector Side)
1	NC	—
2	RXD	IN
3	TXD	OUT
4	NC	—
5	NC	—
6	NC	—
7	RS232	RTS
8	RS232	CTS
9	NC	—

RS232 Protocol Function List

EN1000 RS232 Command Table

Baud Rate: 9600
 Data Bits: 8
 Parity: None
 Stop Bits: 1
 Flow Control: None
 UART16550 FIFO: Disable
 Projector Return (Pass): P
 Projector Return (Fail): F

XX=01-99, projector's ID, XX=00 is for all projectors

Lead Code	Projector ID		Command ID			space	variable	carriage return
~	X	X	X	X	X		n	CR
Fix code One Digit	00		Defined by Optoma 2 or 3 Digit See the Follow content			One Digit	Per item Definition	Fix code One Digit

Function	RS232 Command Code
Power on	~XX00 1
Power off	~XX00 0 ~XX00 2
Resync	~XX01 1
AV Mute on	~XX02 1
AV Mute off	~XX02 0 ~XX02 2
Freeze on	~XX04 1
Unfreeze	~XX04 2 ~XX04 0
IR Function on	~XX11 1
IR Function off	~XX11 0 ~XX11 2
Direct Source Selection	
HDMI 1	~XX12 1
HDMI 2	~XX12 15
VGA	~XX12 5
VGA SCART	~XX12 7
VGA Component	~XX12 8
Component	~XX12 14
S-video	~XX12 9
Video	~XX12 10

Item	Key Definition		ASCII	Pass	Fail
1	Power	n=1	~XX140 n	P	F
2	Laser	N/A			
3	Remote Mouse Up	n=3		P	F
4	Remote Mouse Left	n=4		P	F
5	Remote Mouse Enter	n=5		P	F
6	Remote Mouse Right	n=6		P	F
7	Remote Mouse Down	n=7		P	F
8	Mouse Left Click	n=8		P	F
9	Mouse Right Click	n=9		P	F
10	Up/Page +	n=10		P	F
11	Left/Source	n=11		P	F
12	Enter (for projection MENU)	n=12		P	F
13	Right/Re-SYNC	n=13		P	F
14	Down/Page -	n=14		P	F
15	Keystone +	n=15		P	F
16	Keystone -	n=16		P	F
17	Volume -	n=17		P	F

Appendices

Item	Key Definition		ASCII	Pass	Fail
18	Volume +	n=18		P	F
19	DVI-D/YPbPr/1	n=19		P	F
20	Menu/2	n=20		P	F
21	Zoom/3	n=21		P	F
22	HDMI/4	n=22		P	F
23	Freeze/5	n=23		P	F
24	AV Mute/6	n=24		P	F
25	S-Video/7	n=25		P	F
26	VGA/8	n=26		P	F
27	Video/9	n=27		P	F

OSD/Image/Display/Setup

Main Menu	Sub Menu	Sub Menu 2	Sub Menu 3	Sub Menu 4	Values/Menu Items	RS232 Command Code	
IMAGE	Display Mode (1)				Presentation	~XX20 1	
					Bright	~XX20 2	
					Movie	~XX20 3	
					sRGB	~XX20 4	
					Classroom	~XX20 7	
					Blackboard	~XX20 8	
					User 1	~XX20 5	
					User 2	~XX20 6	
		Contrast (1)			-50~+50	~XX22 n	
		Brightness (1)			-50~+50	~XX21 n	
		Color (1)			-50~+50	~XX45 n	
		Tint (1)			-50~+50	~XX44 n	
		Sharpness (1)			0~15	~XX23 n	
		ADVANCED (1)	Noise Reduction (2)			0 ~ 10	~XX196 n
			Gamma (2)	Film (9a)	Curve Type	-7~+7	~XX182 n
					Offset	-5~+5	~XX183 n
					Reset		~XX206 1
					Exit		NA
				Video (9a)	Curve Type	-7~+7	~XX184 n
					Offset	-5~+5	~XX185 n
					Reset		~XX207 n
					Exit		NA
				Graphics (9a)	Curve Type	-7~+7	~XX186 n
					Offset	-5~+5	~XX187 n
					Reset		~XX208 n
					Exit		NA
			Standard (9a)	Curve Type	-7~+7	~XX188 n	
				Offset	-5~+5	~XX189 n	
				Reset		~XX209 n	
				Exit		NA	
		Color Settings (2)	Color Temp. (2)		Warm	~XX36 1	
					Medium	~XX36 2	
					Cold	~XX36 3	
			Color Settings	Red Gain (2a)	-50~+50	~XX24 n	
				Green Gain (2a)	-50~+50	~XX25 n	
				Blue Gain (2a)	-50~+50	~XX26 n	
			Red Bias (2a)	-50~+50	~XX27 n		
			Green Bias (2a)	-50~+50	~XX28 n		
			Blue Bias (2a)	-50~+50	~XX29 n		

Appendices

Main Menu	Sub Menu	Sub Menu 2	Sub Menu 3	Sub Menu 4	Values/Menu Items	RS232 Command Code	
				Reset (2a)		~XX33 1	
				Exit (2a)		NA	
			Color Space		RGB		~XX37 2
					YUV		~XX37 3
					Auto		~XX37 1
			RGB Channel		Normal		
					Red		
					Green		
					Blue		
				Exit			
	Exit (2)				NA		
DISPLAY	Format (1)				4:3	~XX60 1	
					16:9	~XX60 2	
					LBX	~XX60 5	
					Native	~XX60 6	
	Digital Zoom (1)				0~10	~XX61 n	
	V Image Shift (1)				-50~+50	~XX64 n	
	V Keystone (1)				-20~+20	~XX66 n	
Closed Captioning					On	~XX88 1	
					Off	~XX88 2 ~XX88 0	
SYSTEM	Menu Location (1)				Top Left	~XX72 1	
					Top Right	~XX72 2	
					Center	~XX72 3	
					Bottom Left	~XX72 4	
					Bottom Right	~XX72 5	
	Lamp Settings (1)	Lamp Hours (2)					~XX108 1
		Lamp Reminder (2)				Off	~XX109 0 ~XX109 2
						On	~XX109 1
		Brightness Mode (2)				Bright	~XX110 1
						STD	~XX110 2
		Lamp Reset (2)				No	~XX111 2
					YES	~XX111 1	
		Exit (2)				NA	
	Projection (1)					Front-Desktop	~XX71 1
						Rear-Desktop	~XX71 2
						Front-Ceiling	~XX71 3
						Rear-Ceiling	~XX71 4
	Background Color (1)					Dark Blue	~XX104 1
						Grey	~XX104 3
						Black	~XX104 2
Startup Image	Image				Default	~XX82 1	
					User	~XX82 2	
	Image Capture					~XX83 n	

Appendices

Main Menu	Sub Menu	Sub Menu 2	Sub Menu 3	Sub Menu 4	Values/Menu Items	RS232 Command Code	
	Power Mode (Standby)				ECO	~XX114 1	
					Active	~XX114 2 ~XX114 0	
	Audio Settings	Mute				On	~XX80 1
						Off	~XX80 2 ~XX80 0
		Volume			0~10	~XX81 n	
		Audio Input				Mini	~XX89 1
						RCA	~XX89 2
	Exit					NA	
	Projector ID				00~99	~XX79 n	
	RS232					RS232	~XX86 1
						Network	~XX86 2
	Network (1)	Network State					
		DHCP					
		IP Address					
		Subnet Mask					
		Gateway					
		DNS					
		Apply					
		Exit					NA
	SETUP	Language (1)				English	~XX70 1
					German	~XX70 2	
					French	~XX70 3	
					Italian	~XX70 4	
					Spanish	~XX70 5	
					Portuguese	~XX70 6	
					Polish	~XX70 7	
					Dutch	~XX70 8	
					Swedish	~XX70 9	
					Norwegian/Danish	~XX70 10	
					Finnish	~XX70 11	
					Greek	~XX70 12	
					Traditional Chinese	~XX70 13	
					Simplified Chinese	~XX70 14	
					Japanese	~XX70 15	
					Korean	~XX70 16	
					Russian	~XX70 17	
					Hungarian	~XX70 18	
					Czechoslovak	~XX70 19	
					Arabic	~XX70 20	
			Thai	~XX70 21			
			Turkish	~XX70 22			
			Exit		NA		
Input Filter (1)					HDMI 1	~XX39 1	
					HDMI 2	~XX39 7	
					Component	~XX39 8	
					VGA	~XX39 5	
					S-video	~XX39 9	
					Video	~XX39 10	
				Exit		NA	
Source Lock (1)					Off	~XX100 0 ~XX100 2	
					On	~XX100 1	

Appendices

Main Menu	Sub Menu	Sub Menu 2	Sub Menu 3	Sub Menu 4	Values/Menu Items	RS232 Command Code	
	High Altitude (1)				Off	~XX101 0 ~XX101 2	
					On	~XX101 1	
	Information Hide (1)				Off	~XX102 0 ~XX102 2	
					On	~XX102 1	
	Auto Power Off (1)				0 ~ 60 min	~XX106 n	
		Automatic (2)				Disable	~XX91 0
					Enable	~XX91 1	
	Frequency (2)				-50~+50	~XX73 n	
	Phase (2)				0~63	~XX74 n	
	H. Position (2)				-5~+5	~XX75 n	
	V. Position (2)				-5~+5	~XX76 n	
	Exit (2)					NA	
	White Level (2)				-50~+50	~XX200 n	
	Black Level (2)				-50~+50	~XX201 n	
	Saturation (2)		(Video decoder)			-50~+50	~XX202 n
	Hue (2)					-50~+50	~XX203 n
	IRE (2)					0 IRE / 7.5 IRE	~XX204 n
	Exit (2)						NA
	Black Level (2)			(HDMI)		YCbCr / RGB / Auto	~XX217 n
	Exit					NA	
	Signal Power On (1)				Off	~XX113 0 ~XX113 2	
					On	~XX113 1	
	Security	Security Timer		Month		0~12	~XX77 HHMMDD
				Day		0~30	
			Hour		0~24		
			Exit			NA	
Change Password							
Security Settings					Disable	~XX78 0 ~XX78 2	
					Enable	~XX78 1	
Exit							
Reset (1)				Current	~XX112 1		
				All	~XX112 2		
12V OUT				Off	~XX192 0 ~XX192 2		
				On	~XX192 1		

Information Format: INFOa	Standby Mode	a=0
	Warming up	a=1
	Cooling Down	a=2
	Out of Range	a=3
	Lamp Fail	a=4
	Thermal Switch Error	a=5
	Fan Lock	a=6
	Over Temperature	a=7
	Lamp Hours Running Out	a=8

Function	RS232 command	Response		
Information display	~XX150 1	Okabbbbccdddde		
		a = Power State	On	a=1
			Off	a=0
		b = Lamp Hour		bbbb
		c = Input Source	None	c=0

Appendices

Function	RS232 command	Response		
			HDMI 1	c=1
			HDMI 2	c=2
			VGA	c=3
			S-video	c=4
			Video	c=5
		d = Firmware Version		dddd
		e = Display mode	None	e=0
			Presentation	e=1
			Bright	e=2
			Movie	e=3
			sRGB	e=4
			Classroom	e=5
			Blackboard	e=6
			User1	e=7
			User2	e=8
Input Source	~XX121 1	Oka	None	a=0
			HDMI 1	a=1
			HDMI 2	a=2
			VGA	a=3
			S-video	a=4
			Video	a=5
			Component	a=6
Software Version	~XX122 1	Okdddd		
Display Mode	~XX123 1	Oka	None	a=0
			Presentation	a=1
			Bright	a=2
			Movie	a=3
			sRGB	a=4
			Classroom	a=5
			Blackboard	a=6
			User1	a=7
			User2	a=8
Power State	~XX124 1	Oka	On	a=1
			Off	a=0
Brightness	~XX125 1	Oka		
Contrast	~XX126 1	Oka		
Aspect Ratio	~XX127 1	Oka	4:3	a=0
			16:9	a=1
			LBX	a=2
			Native	a=3
Color Temperature	~XX128 1	Oka	Warm	a=0
			Medium	a=1
			Cold	a=2
Projection Mode	~XX129 1	Oka	Front-Desktop	a=0
			Rear-Desktop	a=1
			Front-Ceiling	a=2
			Rear-Ceiling	a=3
Model Name	~XX151 1	Oka	EH1060	a=1
RS232 Version No	~XX152 1	Oka		

Ceiling Mount Installation

1. To prevent damage to your projector, please use the Optoma ceiling mount.
2. If you wish to use a third party ceiling mount kit, please ensure the screws used to attached a mount to the projector met the following specifications:

- ▶ **Screw type: M4**
- ▶ **Maximum screw length: 11mm**
- ▶ **Minimum screw length: 9mm**



Please note that damage resulting from incorrect installation will invalidate the warranty.



Warning:

1. If you buy ceiling mount from other company, please be sure to use the correct screw size. Screw size will be different on different mounts. It depends on the plate thickness.
2. Be sure to keep at least 10cm gap between the ceiling and the bottom of the projector.
3. Avoid installing the projector near a heat source.

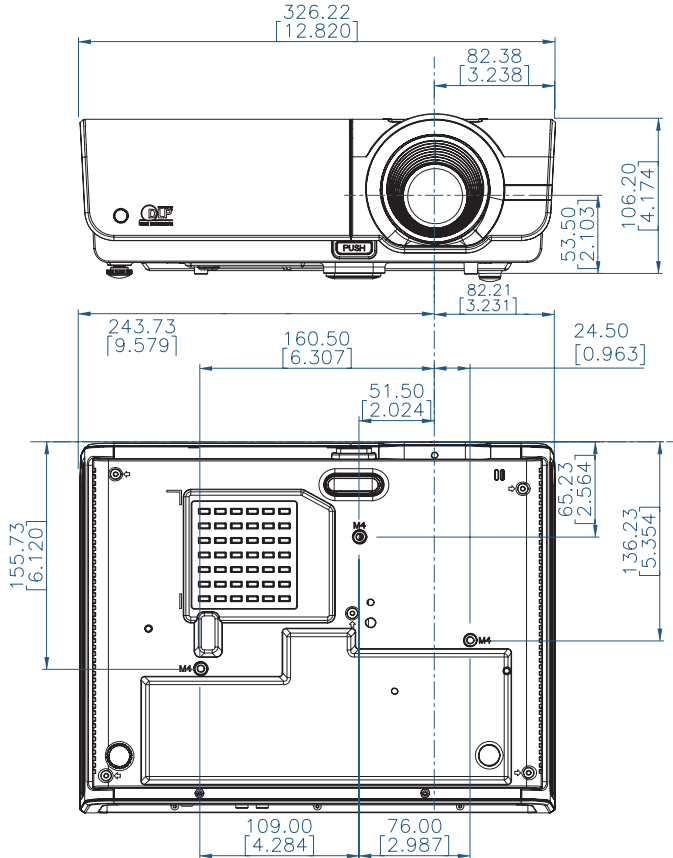

Optoma Global Offices

For service or support please contact your local office.

USA

715 Sycamore Drive
Milpitas, CA 95035, USA
www.optomausa.com

Tel : 408-383-3700
Fax : 408-383-3702
Service : services@optoma.com

Canada

5630 Kennedy Road, Mississauga,
ON, L4Z 2A9, Canada
www.optoma.ca

Tel : 905-361-2582
Fax : 905-361-2581
Service : canadacsragent@optoma.com

Europe

42 Caxton Way, The Watford Business Park
Watford, Hertfordshire,
WD18 8QZ, UK
www.optoma.eu

Tel : +44 (0) 1923 691 800
Fax : +44 (0) 1923 691 888
Service : service@tsc-europe.com

France

Bâtiment E
81-83 avenue Edouard Vaillant
92100 Boulogne Billancourt, France

Tel : +33 1 41 46 12 20
Fax : +33 1 41 46 94 35
Service : savoptoma@optoma.fr

Spain

C/ José Hierro,36 Of. 1C
28522 Rivas VaciaMadrid,
Spain

Tel : +34 91 499 06 06
Fax : +34 91 670 08 32

Deutschland

Werftstrasse 25
D40549 Düsseldorf,
Germany

Tel : +49 (0) 211 506 6670
Fax : +49 (0) 211 506 66799
Service : info@optoma.de

Optoma Scandinavia AS

Lerpeveien 25
3040 Drammen
Norway

Tel : +4732988990
FAX : +4732988999
Service : info@optoma.no

PO.BOX 9515
3038 Drammen
Norway

Latin America

715 Sycamore Drive
Milpitas, CA 95035, USA
www.optoma.com.br

Tel : 408-383-3700
Fax: 408-383-3702
www.optoma.com.mx

Taiwan

231,台北縣新店市民權路108號5樓
電話 : +886-2-2218-2360
服務處 : services@optoma.com.tw

傳真 : +886-2-2218-2313
www.optoma.com.tw
asia.optoma.com

Hong Kong

Unit A, 27/F Dragon Centre, 79 Wing Hong Street,
Cheung Sha Wan Kowloon, Hong Kong
Tel : +852-2396-8968
www.optoma.com.hk

Fax: +852-2370-1222

China

上海市长宁区凯旋路1205号5楼
邮编: 200052
www.optoma.com.cn

电话: +86-21-62947376
传真: +86-21-62947375

Japan

東京都足立区綾瀬 3-25-18
株式会社オーエスエム
E-Mail: info@osscreen.com

サポートセンター: 0120-46-5040
<http://www.os-worldwide.com/>

Korea

WOOMI TECH.CO.,LTD.
4F, Minu Bldg.33-14, Nonhyun-Dong,
Kangnam-Ku, seoul, 135-815,
KOREA

Tel : +82+2+34430004
Fax: +82+2+34430005

Regulation & Safety Notices

This appendix lists the general notices of your Projector.

FCC notice

This device has been tested and found to comply with the limits for a Class B digital device pursuant to Part 15 of the FCC rules. These limits are designed to provide reasonable protection against harmful interference in a residential installation. This device generates, uses and can radiate radio frequency energy and, if not installed and used in accordance with the instructions, may cause harmful interference to radio communications.

However, there is no guarantee that interference will not occur in a particular installation. If this device does cause harmful interference to radio or television reception, which can be determined by turning the device off and on, the user is encouraged to try to correct the interference by one or more of the following measures:

- ■ Reorient or relocate the receiving antenna.
- ■ Increase the separation between the device and receiver.
- ■ Connect the device into an outlet on a circuit different from that to which the receiver is connected.
- ■ Consult the dealer or an experienced radio/television technician for help.

Notice: Shielded cables

All connections to other computing devices must be made using shielded cables to maintain compliance with FCC regulations.

Caution

Changes or modifications not expressly approved by the manufacturer could void the user's authority, which is granted by the Federal Communications Commission, to operate this projector.

Operation conditions

This device complies with Part 15 of the FCC Rules. Operation is subject to the following two conditions:

1. This device may not cause harmful interference and
2. This device must accept any interference received, including interference that may cause undesired operation.

Notice: Canadian users

This Class B digital apparatus complies with Canadian ICES-003.

Remarque à l'intention des utilisateurs canadiens

Cet appareil numérique de la classe B est conforme à la norme NMB-003 du Canada.

Declaration of Conformity for EU countries

- EMC Directive 2004/108/EC (including amendments)
- Low Voltage Directive 2006/95/EC
- R & TTE Directive 1999/5/EC
(if product has RF function)

Disposal instructions



Do not throw this electronic device into the trash when discarding. To minimize pollution and ensure utmost protection of the global environment, please recycle it.